

**INTEGRATED
HARDWARE
COMPONENTS**

GOLA

HORIZONTAL C PROFILE

SYSTEM ACCESSORIES:

FOR INSTALLATION INFORMATION
PLEASE REFER TO THE
GOLA INSTALLATION
LINK ON
SALTINTL.COM

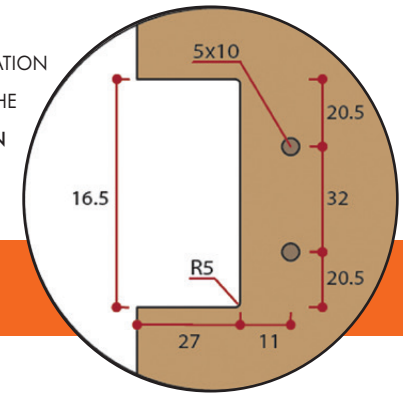

SI.8007.*FINISH*

LENGTH: 9ft

Toolessly Attaches to Cabinets with Support and H Clip (Referenced in Orange).
Complete the Look with Matching End Caps and Corners.

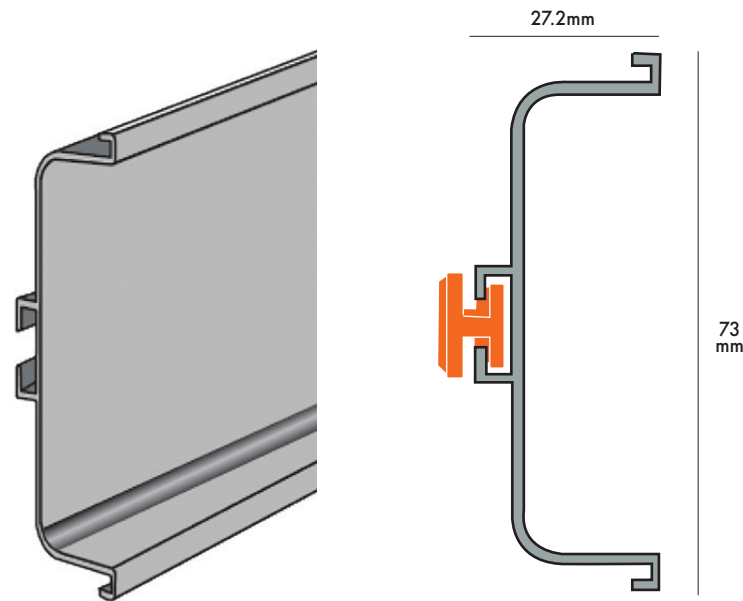

FINISHES

***CA**
Clear Anodized

***SS**
Stainless Steel

***BR**
Brill

***BLK**
Black



**SUPPORT &
H CLIP**

SCREW-IN:
SI.GFXKIT.
SCREW

DOWEL:
SI.GFXKIT

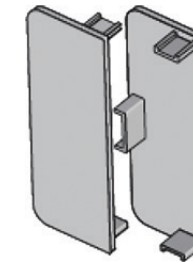
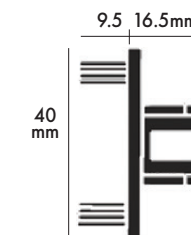
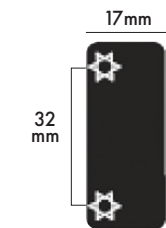

**CLOSED
END CAP**

SET OF LEFT & RIGHT
SI.CEC.8007.
FINISH

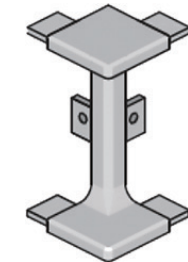
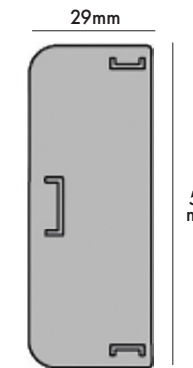

**EXTERIOR
CORNER**

SI.EC8007.*FINISH*

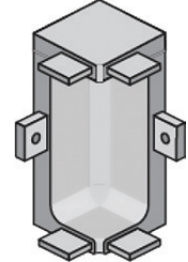
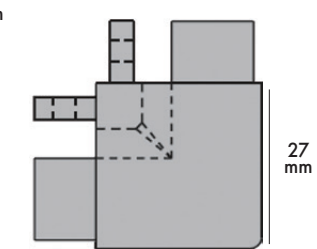
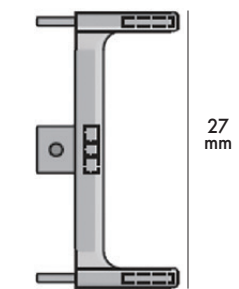

**INTERIOR
CORNER**

SI.IC8007.*FINISH*

